

Article number: 12317000080160

Description: KLEE-coil 317 000 080.160
M8 Hardened/zinc-plated slotted pin

Measures

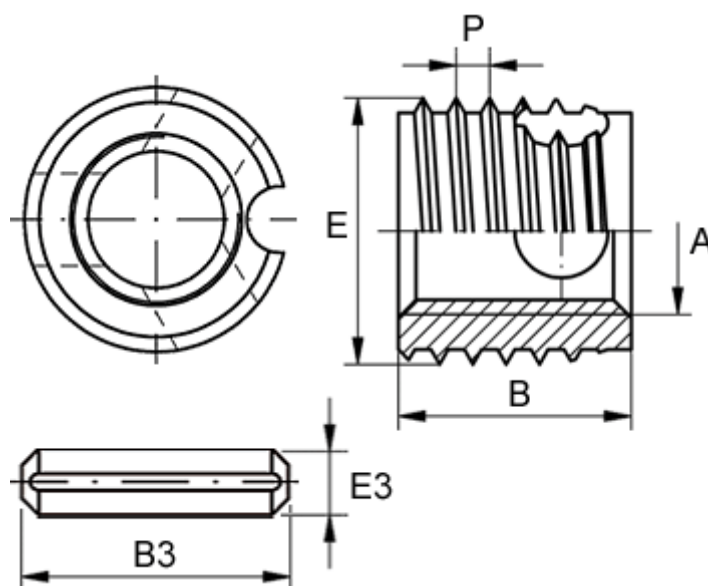

Female thread A	= M8
Length B	= 9
Male thread E	= 12.0
Min hole depth blind hole	= 11
Slotted pin B3	= 6
Slotted pin E3	= 2
Thread pitch P	= 1.50
Type	= 317 000 080 ...